

N 50, Built-in fridge-freezer with freezer at bottom, 177.2 x 54.1 cm, sliding hinge
KI5862SE0G



This built-in fridge-freezer with Fresh Safe keeps fruits and vegetables fresher for longer

- ✓ LowFrost: Reduces frost in the freezer compartment for faster defrosting.
- ✓ Fresh Safe 1 – Flexible fridge drawer for fruit and vegetables.
- ✓ Our safety glass shelves happily shoulder generous loads of delicacies in your fridge
- ✓ Adjustable Glass Shelves – Height adjustable shelves create the space you need for inspiring dishes in your fridge
- ✓ Eco Air Flow – Even air circulation for constant temperatures and fast cooling.

Features

Technical Data

Energy Efficiency Class : E
 Average annual energy consumption in kilowatt hour per year (kWh/a) : 229 kWh/annum
 Sum of volume of frozen compartments : 84 l
 Sum of volume of chill compartments : 183 l
 Airborne acoustical noise emissions : 35 dB(A) re 1 pW
 Airborne acoustical noise emission class : B
 Construction type : Built-in
 Door panel options : Not possible
 Width of the appliance : 541 mm
 Depth of the product : 548 mm
 Required niche size for installation (HxWxD) : 1775.0 x 560 x 550 mm
 Net weight : 53.137 kg
 Fuse protection : 10 A
 Door hinge : Right reversible
 Voltage : 220-240 V
 Frequency : 50 Hz
 Approval certificates : CE, VDE
 Length of electrical supply cord : 230 cm
 Storage Period in Event of Power Failure (h) : 9 h
 Number of compressors : 1
 Number of independent cooling systems : 1
 Interior ventilator : No
 Reversible Door Hinge : Yes
 Number of Adjustable Shelves in fridge compartment (Stck) : 3
 Shelves for Bottles : No
 Frost free system : No
 Installation type : Full-integrated
 Type of hinge : Follow-door



4 242004 252115

N 50, Built-in fridge-freezer with freezer at bottom,
 177.2 x 54.1 cm, sliding hinge
 KI5862SE0G

Features

Performance and Consumption

Functions

- Bright interior LED fridge light

Design features

- Electronic control (LED chain)
- Super Cooling: No
- SuperFreeze function with automatic deactivation
- acoustic alarm

Design features

- 4 safety glass shelves in fridge compartment of which 3 are height adjustable
- 3 door trays, including 1x dairy compartment
- 1 removable door storage compartments.
- 3 door bins

Freshness System

- 1 FreshSafe drawer with humidity control retains freshness for longer.

Food freshness system

- lowFrost freezer
- 3 transparent freezer drawers, 1 bigbox

Dimension and installation

- Dimensions: 177.2 cm H x 54.1 cm W x 54.8 cm D
- Niche Dimensions: 177.5 cm H x 56 cm W x 55 cm D

Key features - Fridge section

- Right hinged door, reversible
- 220 - 240 V

Key features - Freezer section

- 2 x egg tray, 1 x ice cube tray

Country Specific Options

- Based on the results of the standard 24-hour test. Actual consumption depends on usage/position of the appliance.

Design features

Dimension and installation

Additional features

- EU19_EEK_D: E
- Total Volume : 267 l
- Net Fridge Volume : 183 l
- Net Freezer Volume : 84 l
- Net 4* compartment volume : 84 l
- Freezing capacity 24h : 4.2 kg
- Annual Energy Consumption: 229 kWh/a
- Climate Class: SN-ST
- EU19_Fast freezer facility_D
- Noise Level : 35 dB , EU19_Noise emission class_D: B
- Temperature rise time : EU19_Temperature rise time_D: 9 H

N 50, Built-in fridge-freezer with freezer at bottom,
 177.2 x 54.1 cm, sliding hinge
 KI5862SE0G

Dimensioned drawings

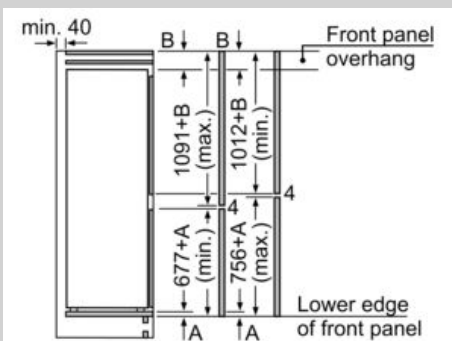
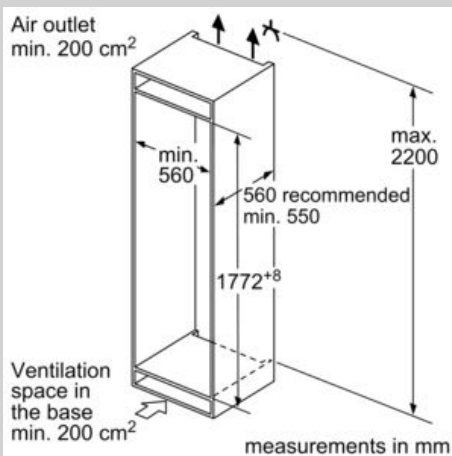
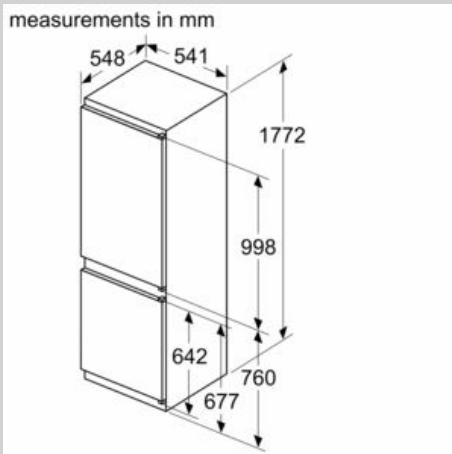

The specified unit door dimensions
 are valid for a door gap of 4 mm.

measurements in mm